

**VE.NET GMDSS PANEL**

USER MANUAL  
INSTALLATION MANUAL



Copyrights © 2007 Victron Energy B.V.  
All Rights Reserved

This publication or parts thereof, may not be reproduced in any form, by any method, for any purpose.

For conditions of use and permission to use this manual for publication in other than the English language, contact Victron Energy B.V.

VICTRON ENERGY B.V. MAKES NO WARRANTY, EITHER EXPRESSED OR IMPLIED, INCLUDING BUT NOT LIMITED TO ANY IMPLIED WARRANTIES OF MERCHANTABILITY OR FITNESS FOR A PARTICULAR PURPOSE, REGARDING THESE VICTRON ENERGY PRODUCTS AND MAKES SUCH VICTRON ENERGY PRODUCTS AVAILABLE SOLELY ON AN "AS IS" BASIS.

IN NO EVENT SHALL VICTRON ENERGY B.V. BE LIABLE TO ANYONE FOR SPECIAL, COLLATERAL, INCIDENTAL, OR CONSEQUENTIAL DAMAGES IN CONNECTION WITH OR ARISING OUT OF PURCHASE OR USE OF THESE VICTRON ENERGY PRODUCTS. THE SOLE AND EXCLUSIVE LIABILITY TO VICTRON ENERGY B.V., REGARDLESS OF THE FORM OF ACTION, SHALL NOT EXCEED THE PURCHASE PRICE OF THE VICTRON ENERGY PRODUCTS DESCRIBED HERE IN.

Victron Energy B.V. reserves the right to revise and improve its products as it sees fit. This publication describes the state of this product at the time of its publication and may not reflect the product at all times in the future.

## VE.Net GMDSS Panel

### INSTALLATION AND USER MANUAL

#### Index

1	Contents of the box .....	4
2	Introduction .....	4
3	Definitions .....	4
4	VE.Net GMDSS panel .....	4
5	Prerequisites .....	4
6	Installation and configurations instructions .....	4
7	The VE.Net GMDSS Panel .....	5
7.1	Using the Panel .....	5
7.2	Where to find "Panel Setup" menu .....	6
7.3	The "Panel Setup" menu .....	6
7.4	Access level .....	6
7.5	Alarms .....	7
8	GMDSS Monitor .....	8
8.1	Quick status line .....	8
8.2	Read out menu .....	8
8.3	Settings of the GMDSS Monitor .....	9
8.4	Where to find the "Setup Alarms" menu .....	9
8.5	The "Setup Alarms" menu .....	9
8.6	Where to find the "Setup Controller" menu .....	10
8.7	The "Setup Controller" menu .....	10
9	Technical specifications .....	10

## 1 Contents of the box

- 1x VE.Net GMDSS Panel
- 4x Black screw to mount the panel
- 1x Panel cutout
- 1x Installation and user manual

## 2 Introduction

Victron Energy has established an international reputation as a leading designer and manufacturer of energy systems. Our R&D department is the driving force behind this reputation. It is continually seeking new ways of incorporating the latest technology in our products. Each step forward results in value-added technical and economical features.

## 3 Definitions

- |               |   |
|---------------|---|
| GMDSS charger | in this manual a GMDSS charger refers to a Victron Energy Skylla-TG GMDSS charger, which can be remotely monitored by the VE.Net GMDSS panel. |
| Battery       | Whenever battery is used in this manual it can equally well refer to a battery bank, depending on your setup.                                 |
| Panel         | refers to the VE.Net GMDSS panel  |

## 4 VE.Net GMDSS panel

Since the GMDSS charger is in general located at a different location than the ships control, the GMDSS charger of Victron Energy can be remotely monitored and alarms are available where they should. The VE.Net GMDSS panel does not only monitor the state of the charger, but provides information about the connected battery as well.

## 5 Prerequisites

- This manual assumes that the GMDSS charger is already installed. (If this is not the case refer to the appropriate manual of the GMDSS charger)

## 6 Installation and configurations instructions

1. Mount the panel
2. If required connect the alarm relay. Refer to figure 1 for the locations of the connectors.
3. Connect the panel to the GMDSS charger with a standard straight UTP cable.  
(The VE.Net GMDSS Panel will also be powered from this cable)
4. The panel will start automatically and establish a connection with the GMDSS charger
5. The panel displays the current state of the battery.

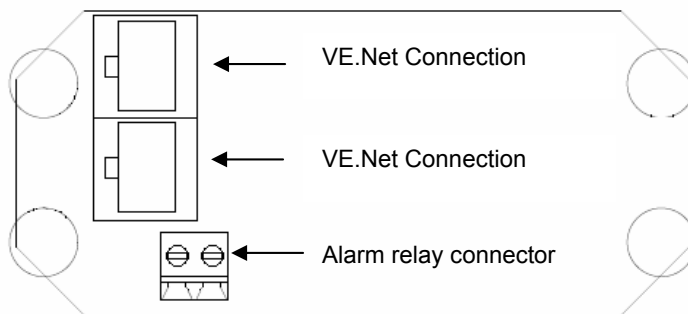
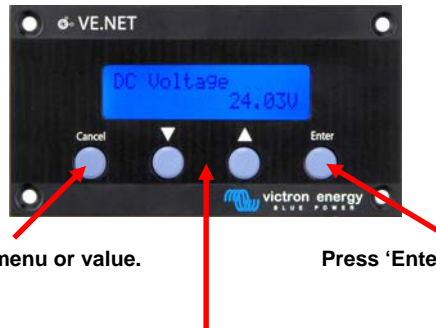

Figure 1. VE.Net GMDSS Panel Connections

## 7 The VE.Net GMDSS Panel

### 7.1 Using the Panel



Press cancel to leave a device, menu or value.

Press 'Enter' to enter a device, menu or to change a value.

Press the up and down switch to change a value or navigate through a menu.

#### Reset the panel

To reset the panel, press and hold "Cancel" for three seconds

#### Navigating through the menu's

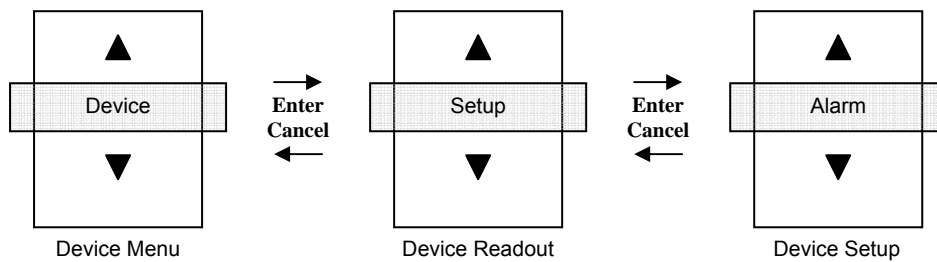

#### How to change a value with a VE.Net GMDSS panel

When a value is changeable you will see a little arrow in the lower left corner of the display.

If a value in the setup menu must be changed press enter. And the value will start to blink. If the value is blinking press up and down to change it. Press enter again and the new value will be stored. If the cancel button is pressed before the new value is stored it will return to its original value.

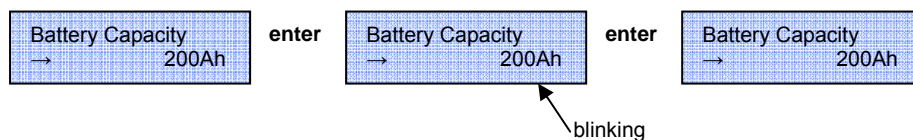

#### Devices

The GMDSS system contains two devices.

- The GMDSS monitor, which shows the state of the battery connected to the GMDSS charger.
- Panel Setup, which allows control over the panel itself

## 7.2 Where to find "Panel Setup" menu

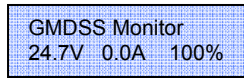

Step 1.) Press "▼" to scroll through the menu until you see "Panel Setup".



Step 2.) Press "Enter" to enter the "Panel Setup"

## 7.3 The "Panel Setup" menu

The properties of the panel are clarified in the table below. All values except the software version can be changed. In paragraph 7.1 it is explained how values can be adjusted.

Panel Setup		Default	Range	Step size
Contrast	Contrast of the display	100	0-100%	5%
Backlight	Intensity of the backlight	30	0-100%	5%
Backlight off	Time before the backlight turns off automatically	10s	10s, 30s, 1 min, Never	
Access level	In order to prevent accidental changes to settings, most setup parameters are hidden in user mode	User and install	User, User and Install	
Restrict Access	Disables changing the access level, only possible for OEM installers	No	Yes, No	
Restart panel	Restart the panel	No	No-Yes	
Software version	Version of the software in the panel	-	-	-

## 7.4 Access level

Many device options only need to be changed during installation, and should not be adjusted during normal use. The panel has an access level setting to prevent accidental changes to the panel during normal use. Setting the panel access level to "user and install" mode allows access to all menu items. Setting the access level to "user" mode will hide all installation options. To view the hidden items again, simply set the access level setting back to "user and install" mode.

OEM installers can use the restrict access option to password protect the access level of the panel, in order to prevent users from changing the installation settings. The password is available on request from Victron Energy.

## 7.5 Alarms

Whenever an alarm is active on the GMDSS charger, the VE.Net GMDSS panel will draw attention from the user while showing relevant information on the screen. The relay will also indicate the presences of an alarm. The relay is closed during normal operation. It is open for as long as one or more alarm conditions are present. The behavior of the panel with respect to alarms is described in more detail below

### If a new alarm conditions is present

- The audible alarm becomes active
- The relay is open
- the screen blinks
- Information about the alarm is shown on the screen, mentioning:
  - Mentioning that an alarm is active and on which device
  - Continuously alternated with a description of the alarm and relevant information.

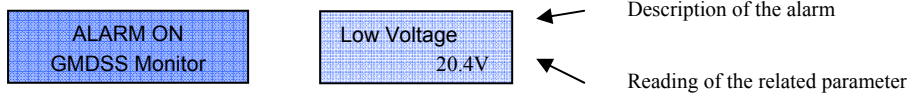

### Confirming the alarm

Press enter to confirm that the alarm has been noticed.

- The audible alarm silences
- The relay remains open
- the screen continues to blink as long as the alarm condition is present
- A reminder of the alarm will periodically be shown

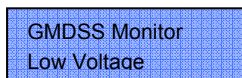

### The alarm condition is removed

- The relay is closed
- If the alarm condition was confirmed on the panel, it will resume normal operation.
- If the alarm condition was not yet confirmed the audible alarm will silence and information about the alarm will remain visible on the screen to indicate that an alarm has occurred. By pressing enter normal operation is resumed.

If multiple alarms are present at the same time, all of them must be confirmed once and all alarms will be repeated. The relay will close after all alarm conditions are removed.

## 8 GMDSS Monitor

### 8.1 Quick status line

The GMDSS monitor is designed to give quick access to all relevant information, without having to scroll through abundant information. The 'quick status' simultaneously displays the most important parameters; the battery voltage, the battery current and the state-of-charge (SOC). In the root menu of the VE.Net GMDSS Panel you will see this screen

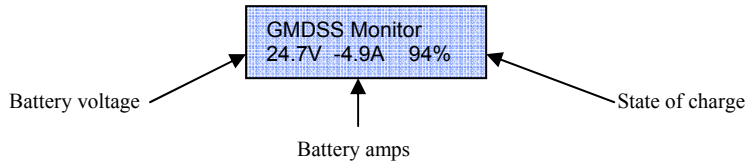

#### Notes:

- 1) You can always return to this position by pressing "Cancel" repeatedly.
- 2) If you can't see the state of charge, the GMDSS monitor isn't synchronized with the battery yet. It can take some time before the GMDSS charger completely charges the battery.

Quick status	
DC Voltage	Displays the actual voltage of the battery.
DC Current	Displays the DC current that flows in or out of the batteries.
State of charge	The state of charge is a representation of the energy left in the battery 100% is full and 0% is empty. This is the best way to see when the batteries need to be recharged. Note that most battery types will be damaged if they are discharged below 50%.

### 8.2 Read out menu

To go to the read out menu, press "Enter" when you are looking at the quick status line. In this menu you will find the following read outs. Notice: these read out only have a meaning in case of a charger or mains failure.

Read out menu	
Consumed Ah	Displays the used ampere hours since the battery was fully charged.
Time to go	Displays time left before the batteries need to be recharged at the current load.



### 8.3 Settings of the GMDSS Monitor

In order to prevent accidental change of the settings of the GMDSS monitor, access to setup values during operation should in general be prevented. If the setup values are not visible, make sure the panel is in "User and Install" mode. For details about the access level, refer to paragraph 7.4. If the OEM installer has locked the panel at the user level, it is not possible to change the access level!

### 8.4 Where to find the "Setup Alarms" menu

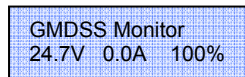

Step 1.) Press "Enter" to enter the GMDSS Monitor menu.

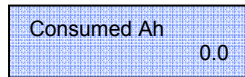

Step 2.) Press "▼" to scroll through the menu until you see "Setup Alarms".

**Note:** If you can't find the Setup Alarms" menu, make sure that your panel is in "User and Install" mode.

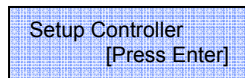

Step 3.) Press "Enter" to enter the "Setup Controller" menu.

### 8.5 The "Setup Alarms" menu

Several alarms can be adjusted to suit the needs of a particular setup. The High Voltage and Low Voltage alarms are however always enabled and can not be turned off. The "charger failure" alarm is also always enabled and indicates the failure of the GMDSS charger to charge the battery.

Setup Alarms		Default	Range	Step size
Low Voltage	The DC Voltage has to be below this threshold to trigger the Low Voltage alarm.	20	8 - 33	0.1
Low Voltage Clr	The threshold that has to be reached again to cancel a Low Voltage alarm.	22	8 - 33	0.1
High Voltage	The DC Voltage has to be above this threshold to trigger the High Voltage alarm.	32	8 - 33	0.1
High Voltage Clr	The threshold that has to be reached again to cancel a High Voltage alarm.	31	8 - 33	0.1
Low SOC	The low State of Charge threshold that will activate the alarm.	60%	0 - 100	1
Low SOC Clr	The State of Charge threshold that has to be reached to cancel a State of Charge alarm.	60%	0 - 100	1
Low SOC Alarm	Enables and disables the low SOC alarm.	off	on - off	
Low Current	The current has to be below threshold to trigger the Low Current alarm.	-100	-100 - 100	0.5
Low Current Clr.	The threshold that has to be reached again to cancel a Low Current alarm.	-98	-100 - 100	0.5
Low Current Alarm	Enables and disables the low current alarm.	off	on-off	
High Current	The current has to be above this threshold to trigger the High Current alarm.	35	-100 - 100	0.5
High Current Clr	The threshold that has to be reached again to cancel the High Current alarm.	32	-100 - 100	0.5
High Current	Enables and disables the high Current Alarm.	off	on - off	

### 8.6 Where to find the "Setup Controller" menu

GMDSS Monitor 24.7V 0.0A 100%
----------------------------------

Step 1.) Press "Enter" to enter the GMDSS Monitor menu.

Consumed Ah 0.0
--------------------

Step 2.) Press "▼" to scroll through the menu until you see "Setup Controller".

Setup Controller [Press Enter]
-----------------------------------

Step 3.) Press "Enter" to enter the Setup Controller menu.

### 8.7 The "Setup Controller" menu

Setup Controller		Default	Range	Step size
Battery Capacity	The battery capacity in amp hours (Ah) at a 20h discharge rate.	200Ah	20-65535	5
Volt charged par	The battery controller considers the battery as fully charged if the voltage is above this level.	26.4V	8-33	0.1
Curr charged par	If the charge current is below this percentage of the battery capacity, the battery can be considered as fully charged.	4%	1-10	1
Charged time par	The minimum time that the above two parameters must be met to consider the battery as fully charged.	4 min	1-4	1
Charge eff. Factor	When a battery is charged, energy is lost. The charge efficiency factor compensates for the lost energy, where 1 is no loss of energy and 0.5 is a 50% loss of energy.	0.9	0.5-1	0.05
Resynchronize?	Resets the state of charge manually to 100%.			

## 9 Technical specifications

<b>VE.Net</b>	
Maximum cable length	25 meter
<b>VE.Net GMDSS Panel</b>	
<b>VPN</b>	
Power supply voltage range	9 – 35 V DC
Operating temp. range	-20 – +50°C (0 - 120°F)
Potential free contact	3A / 30 V DC / 250 V AC / (Normally closed)
<b>ENCLOSURE</b>	
Measurements front panel (w x h)	12 x 6,5 cm (Standard PROS3 Panel)
Measurements body (w x h)	10 x 4,5 cm
Weight	0,1 Kg

### Contact:

Victron Energy  
 De Paal 35  
 1351JG Almere  
 The Netherlands

T: +31 (0)36 535 9700  
 F: +31 (0)36 531 1666

info@victronenergy.com  
 www.victronenergy.com

revision 1.00